

# 5<sup>th</sup> Generation 1200V/15A SiC Schottky Barrier Diode

## Features

- Revolutionary semiconductor material - Silicon Carbide (SiC)
- No reverse recovery
- High-speed switching performance
- Temperature-independent switching behavior
- System cost / size savings due to reduced cooling requirements
- Junction temperature range from -55°C to 175°C
- RoHS compliant

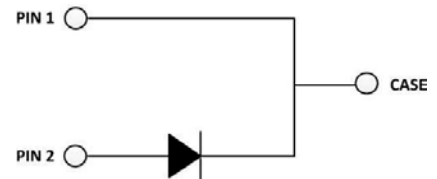

Package Type: TO-252-2L

## Potential Applications

- Industrial power supplies: Industrial UPS
- Battery chargers
- Solar inverters
- Switch mode power supplies



## Description

The SDS120J015D5 SiC Schottky Barrier Diode (SBD) has been developed using Sanan’s advanced 5<sup>th</sup> generation SiC SBD technology with the highest performance and reliability. It registers higher efficiency, higher operation temperature and lower loss and can be operated at higher frequency than Si-based solutions. As to the Schottky structure, it shows no recovery at turn-off and allows a low leakage current with reverse voltage up to 1200V. It can contribute to system miniaturization and achieve lightweight system design. Using RoHS compliant components, it is qualified for use in industrial application.

## Product Specifications

Device	V <sub>RRM</sub>	I <sub>F</sub> (135°C)	V <sub>F</sub> (25°C)	Q <sub>C</sub>	Marking
SDS120J015D5	1200V	22A	1.40V	70nC	DS120015D5

## CONTENTS

Features.....	1
Potential Applications.....	1
Description.....	1
Product Specifications .....	1
Table 1. Maximum Ratings .....	3
Table 2. Thermal Resistance .....	3
Table 3. Static Electrical Characteristics .....	4
Table 4. Dynamic Electrical Characteristics.....	4
Electrical Characteristic Diagrams.....	5
Package Information .....	7
Recommended Solder Pad Layout.....	8
Ordering Information .....	8
Important Notices - Read Carefully .....	9
Warning .....	9

**Table 1. Maximum Ratings**

(T<sub>c</sub> = 25°C, unless otherwise specified)

Parameter	Symbol	Value	Unit	Test conditions
Repetitive peak reverse voltage	V <sub>RRM</sub>	1200	V	T <sub>C</sub> = 25°C
Surge peak reverse voltage	V <sub>RSM</sub>	1200		T <sub>C</sub> = 25°C
DC reverse voltage	V <sub>DC</sub>	1200		T <sub>C</sub> = 25°C
Continuous forward current	I <sub>F</sub>	42	A	T <sub>C</sub> = 25°C
		22		T <sub>C</sub> = 135°C
		15		T <sub>C</sub> = 154°C
Surge non-repetitive forward current	I <sub>FSM</sub>	154	A	T <sub>C</sub> = 25°C, t <sub>p</sub> = 10ms, half sine pulse
		137		T <sub>C</sub> = 150°C, t <sub>p</sub> = 10ms, half sine pulse
Non-repetitive peak forward current	I <sub>F,Max</sub>	974	A	T <sub>C</sub> = 25°C, t <sub>p</sub> = 10μs, pulse
Surge repetitive forward current	I <sub>FRM</sub>	75	A	T <sub>C</sub> = 25°C, t <sub>p</sub> = 10ms, half sine wave D = 0.1
Power dissipation	P <sub>tot</sub>	234	W	T <sub>C</sub> = 25°C
i <sup>2</sup> t value	∫i <sup>2</sup> dt	118	A <sup>2</sup> s	T <sub>C</sub> = 25°C, t <sub>p</sub> = 10ms
Operating junction temperature	T <sub>j</sub>	-55~175	°C	
Storage temperature	T <sub>stg</sub>	-55~175	°C	

**Table 2. Thermal Resistance**

Parameter	Symbol	Values			Unit	Test condition
		Min.	Typ.	Max.		
Thermal resistance from junction to case	R <sub>th(j-c)</sub>	/	0.64	/	°C/W	

**Table 3. Static Electrical Characteristics**

(T<sub>j</sub> = 25°C, unless otherwise specified)

Parameter	Symbol	Values			Unit	Test conditions
		Min.	Typ.	Max.		
DC blocking voltage	V <sub>DC</sub>	1200	/	/	V	I <sub>R</sub> = 100 μA
Forward voltage	V <sub>F</sub>	/	1.40	1.60	V	I <sub>F</sub> = 15A, T <sub>j</sub> = 25°C
		/	2.00	2.40		I <sub>F</sub> = 15A, T <sub>j</sub> = 175°C
Reverse current	I <sub>R</sub>	/	5	60	μA	V <sub>R</sub> = 1200V, T <sub>j</sub> = 25°C
		/	20	240		V <sub>R</sub> = 1200V, T <sub>j</sub> = 175°C

**Table 4. Dynamic Electrical Characteristics**

(T<sub>j</sub> = 25°C, unless otherwise specified)

Parameter	Symbol	Values			Unit	Test conditions
		Min.	Typ.	Max.		
Total capacitance	C	/	1013	/	pF	V <sub>R</sub> = 0V, f = 1MHz
		/	65	/		V <sub>R</sub> = 400V, f = 1MHz
		/	47	/		V <sub>R</sub> = 800V, f = 1MHz
Total capacitive charge	Q <sub>C</sub>	/	70	/	nC	V <sub>R</sub> = 800V
Capacitance stored energy	E <sub>C</sub>	/	20	/	μJ	V <sub>R</sub> = 800V

### Electrical Characteristic Diagrams

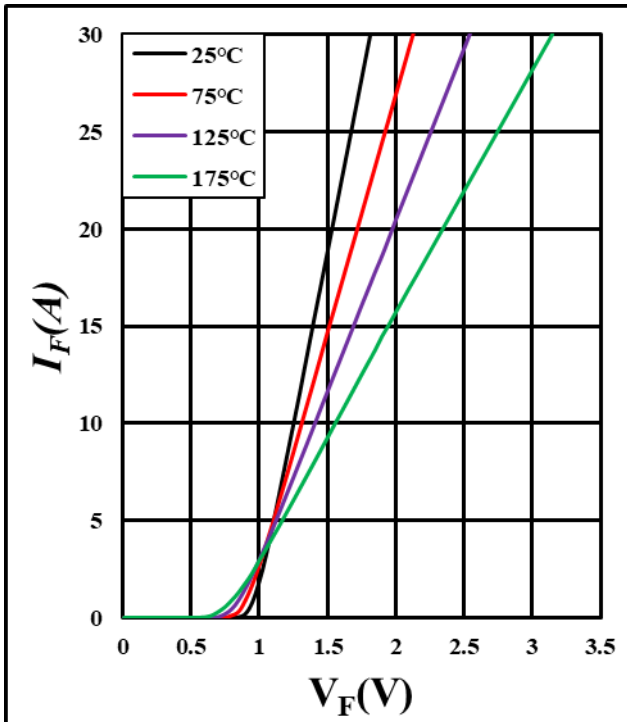

Figure 1. Forward characteristics

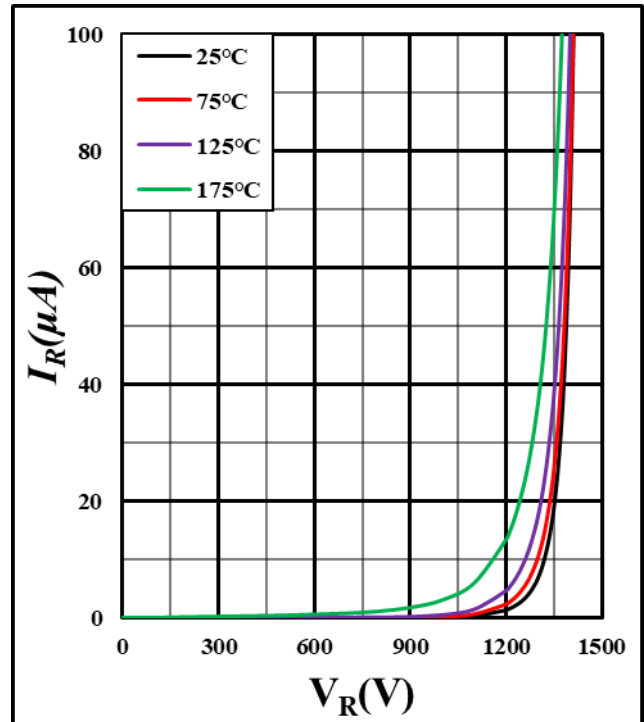

Figure 2. Reverse characteristics

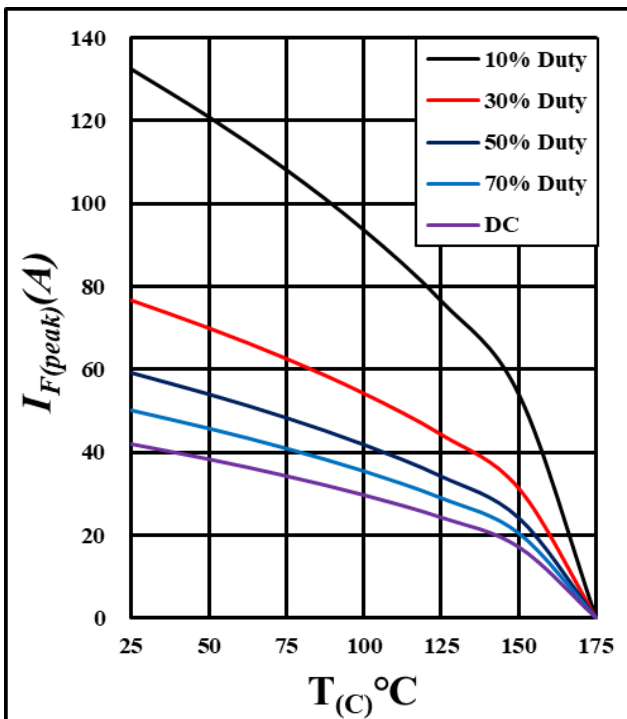

Figure 3. Current derating

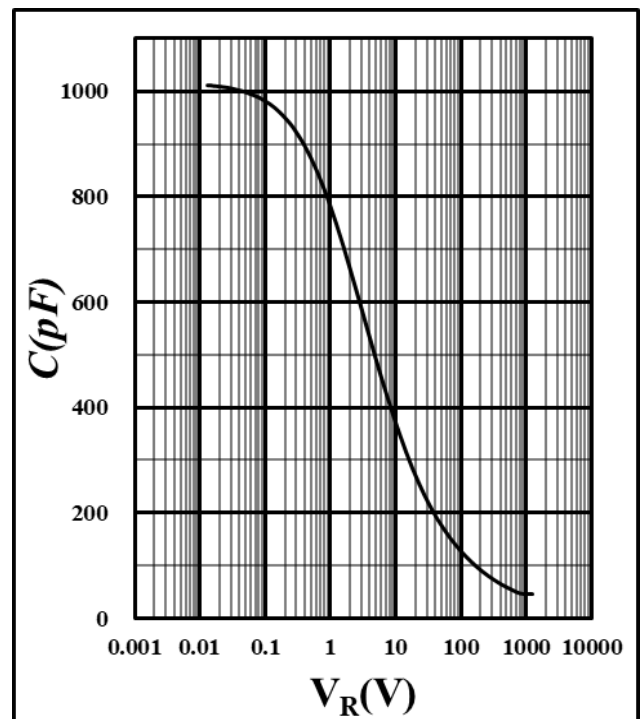

Figure 4. Capacitance vs. reverse voltage

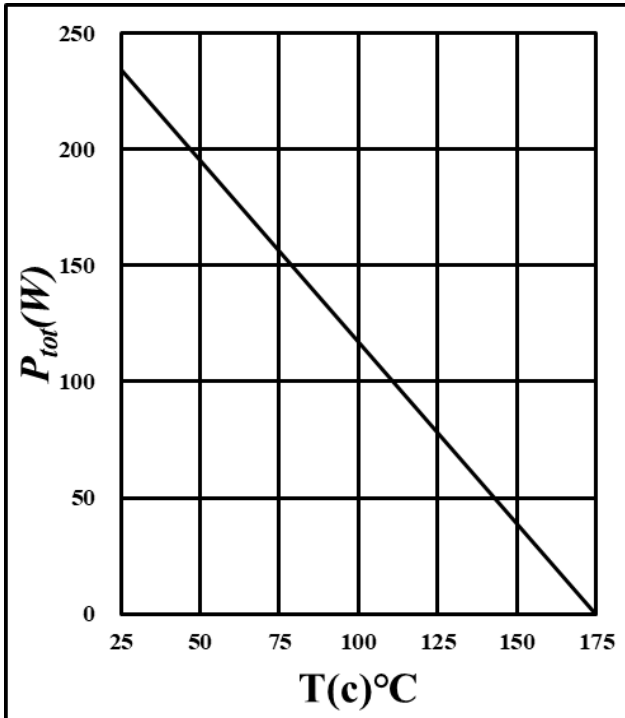

Figure 5. Power derating

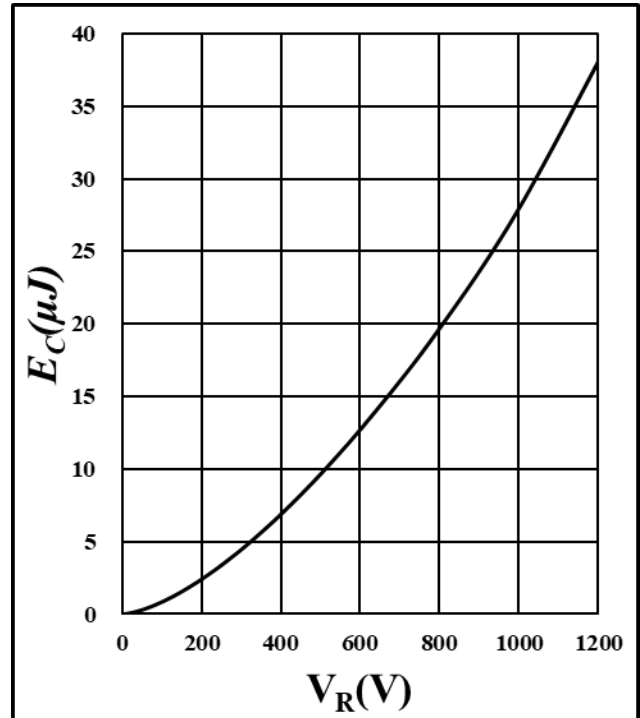

Figure 6. Capacitance stored energy

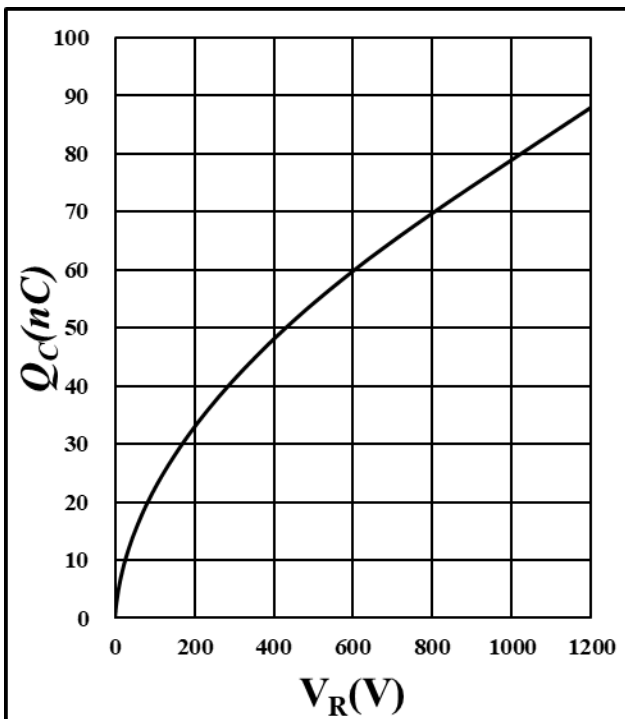

Figure 7. Total capacitance charge vs. reverse voltage

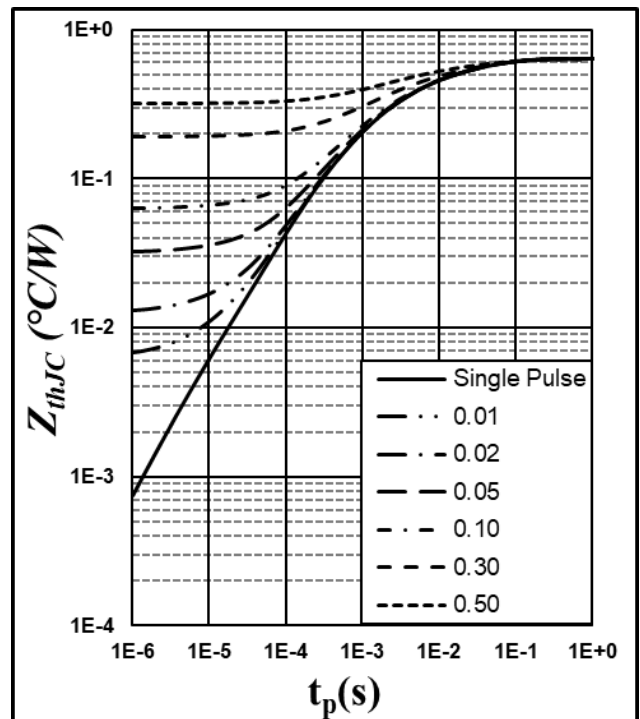
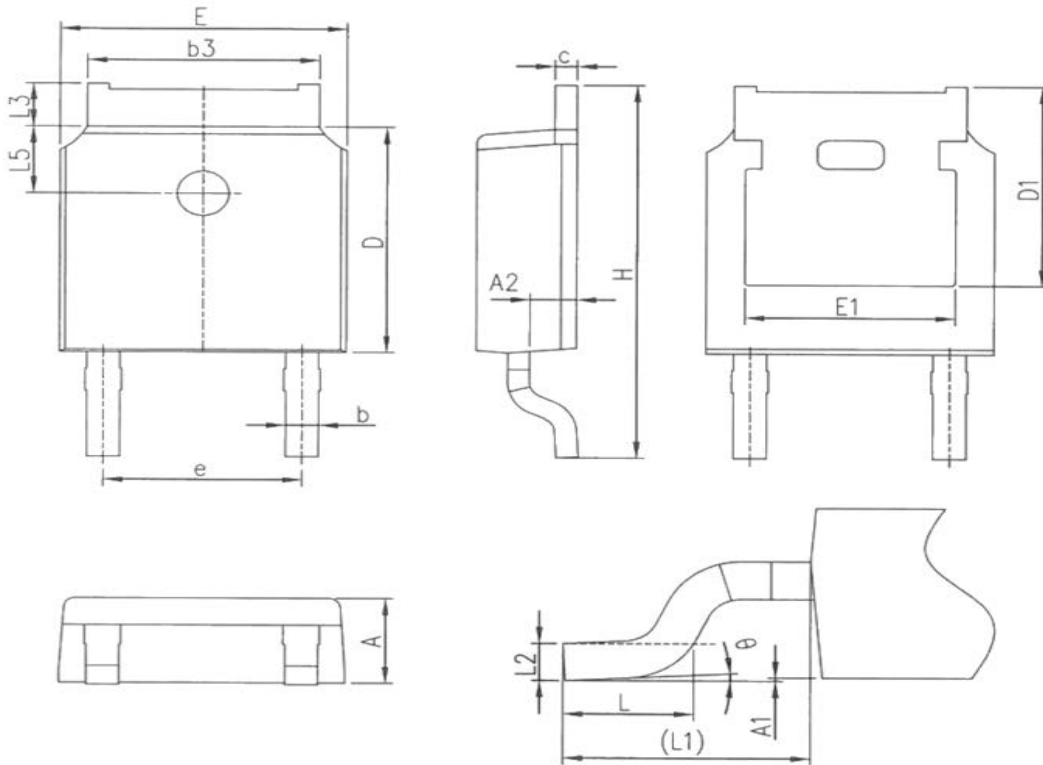

Figure 8. Transient Thermal Impedance  
(Junction - Case)

**Package Information**



SYMBOL	mm		
	MIN	NOM	MAX
A	2.20	2.30	2.38
A1	0.00	-	0.20
A2	0.97	1.07	1.17
b	0.68	0.78	0.90
b3	5.20	5.33	5.46
c	0.43	0.53	0.61
D	5.98	6.10	6.22
D1	5.30REF		
E	6.40	6.60	6.73
E1	4.63	-	-
e	4.572BSC		
H	9.40	10.10	10.50
L	1.38	1.50	1.75
L1	2.90REF		
L2	0.51BSC		
L3	0.88	-	1.28
L5	1.65	1.80	1.95
$\theta$	0°	-	8°

## Recommended Solder Pad Layout

Note: All dimensions are in mm

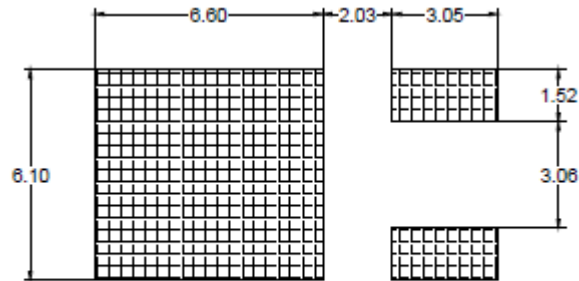

TO-252-2L

## Ordering Information

Part number	SDS120J015D5-ISARH
Package	TO-252-2L
Unit quantity	2500 EA
Packing type	Tape & Reel

## Important Notices – Read Carefully

Before you use our products, you are requested to carefully read this document and fully understand its contents. Sanan Semiconductor Co., Ltd. shall not be in any way responsible or liable for failure, malfunction or accident arising from the use of Sanan's products.

Sanan Semiconductor Datasheets are subject to change. Information presented in this document is from the characterization of engineering lots. Sanan Semiconductor Co., Ltd reserves the right to change limits, test conditions, and dimensions without notice. Information contained in this document are typical values and shall in no event be regarded as a guarantee of characteristics. With respect to any information regarding the application of the product, Sanan hereby disclaims all warranties and liabilities of any kind. The information in this document is exclusively for trained technical staff. It is the responsibility of the customer's technical department to decide the suitability of the product in the customer's application and Sanan Semiconductor Co., Ltd assumes no responsibility or liability whatsoever for the use of the information contained in this document.

In case there is any clause in this document or in any other documents which is contradictory to this clause, this clause shall prevail. This clause shall survive after termination of this document.

## Warning

Due to technical requirements, Sanan's products may contain dangerous substances. For detailed information about the substance(s), please contact the Sanan office. Sanan Semiconductor Co., Ltd bears no responsibility for any damage whatsoever due to the substance(s) used in Sanan's products.

## Contact info

Website: <https://www.sanan-semiconductor.com/>  
<https://www.sanan-semiconductor.com/en>