

1200V/80A

SiC Schottky Barrier Diode

Characteristic

- Zero Reverse Recovery Current
- Ceramic Package Provides 2.5kV Isolation
- Positive temperature coefficient
- Temperature-independent performance
- High-speed switching
- Low switching loss
- Low heat dissipation requirements

Application

- Anti-Parallel diode
- Uninterruptible Power Supply (UPS)
- Induction heating
- Welding equipment

Product Description

V_{RRM}	1200	V
$I_F(110^\circ\text{C})$	94	A
Q_C	446	nC

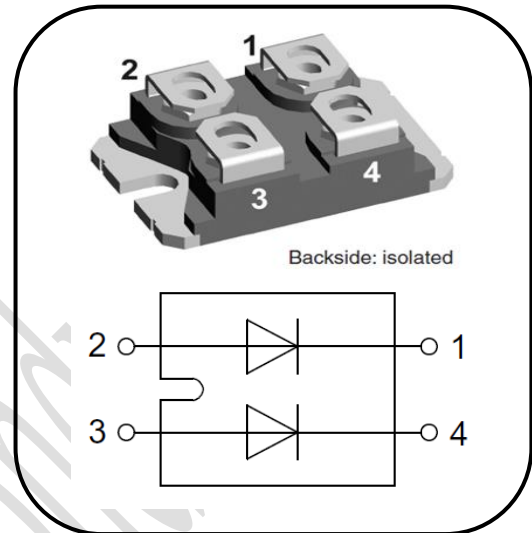

Device	Package	Marking
SLS120J080A	SOT-227	SLS120J080A

Absolute Maximum Ratings (per leg)

Parameter	Symbol	Value	Unit	Test Conditions
Reverse voltage (Repetitive peak)	V_{RRM}	1200	V	$T_C=25^\circ\text{C}$
Reverse Voltage (Surge peak)	V_{RSM}	1200		$T_C=25^\circ\text{C}$
Reverse voltage (DC)	V_{DC}	1200		$T_C=25^\circ\text{C}$
Continuous forward current	I_F	156	A	$T_C=25^\circ\text{C}$
		94		$T_C=110^\circ\text{C}$
		80		$T_C=128^\circ\text{C}$
Surge non-repetitive forward current	I_{FSM}	640	A	$T_C=25^\circ\text{C}, t_p=10\text{ms}, \text{half Sine Pulse}$
Total power dissipation	P_{TOT}	428	W	$T_C=25^\circ\text{C}$
i^2t value	$\int i^2 dt$	2048	A^2s	$T_C=25^\circ\text{C}, t_p=10\text{ms}$
Virtual junction temperature	T_{VJ}	-40~175	$^\circ\text{C}$	
Operation temperature	T_{OP}	-40~150	$^\circ\text{C}$	
Storage temperature	T_{stg}	-40~150	$^\circ\text{C}$	
Mounting Torque	M	1.1	Nm	M4 Screw

Thermal Characteristics (per leg)

Parameter	Symbol	Values			Unit	Test Condition
		Min.	Typ.	Max.		
Thermal resistance	$R_{th(j-c)}$	/	0.35	/	°C/W	

Electrical Characteristics (per leg) $T_j=25^\circ\text{C}$

Parameter	Symbol	Values			Unit	Test Condition
		Min.	Typ.	Max.		
DC blocking voltage	V_{DC}	1200	/	/	V	$I_R=200\ \mu\text{A}$
Forward voltage	V_F	/	1.40	1.60	V	$I_F=80\text{A}, T_j=25^\circ\text{C}$
		/	1.90	2.30		$I_F=80\text{A}, T_j=175^\circ\text{C}$
Reverse current	I_R	/	15	240	μA	$V_R=1200\text{V}, T_j=25^\circ\text{C}$
		/	80	1280		$V_R=1200\text{V}, T_j=175^\circ\text{C}$
Total capacitance	C	/	6465	/	pF	$V_R=0\text{V}, f=1\text{MHz}$
		/	417	/		$V_R=400\text{V}, f=1\text{MHz}$
		/	310	/		$V_R=800\text{V}, f=1\text{MHz}$
Total capacitive charge	Q_C	/	446	/	nC	$V_R=800\text{V}$
Capacitance Stored Energy	E_C	/	127	/	μJ	$V_R=800\text{V}$

Typical Electrical Characteristics Curves

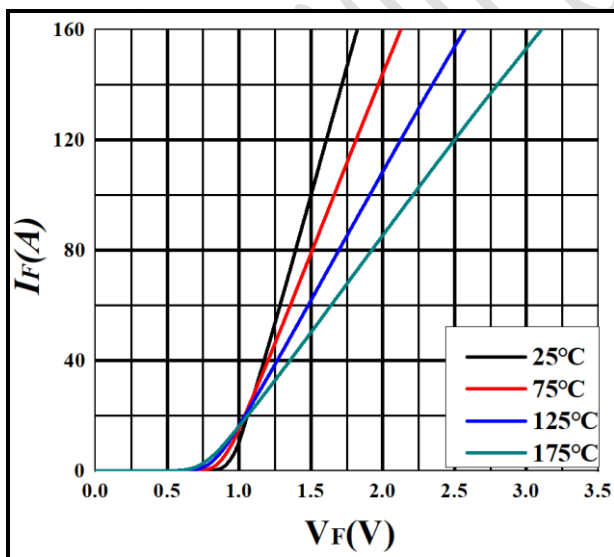

Figure 1. Forward Characteristics

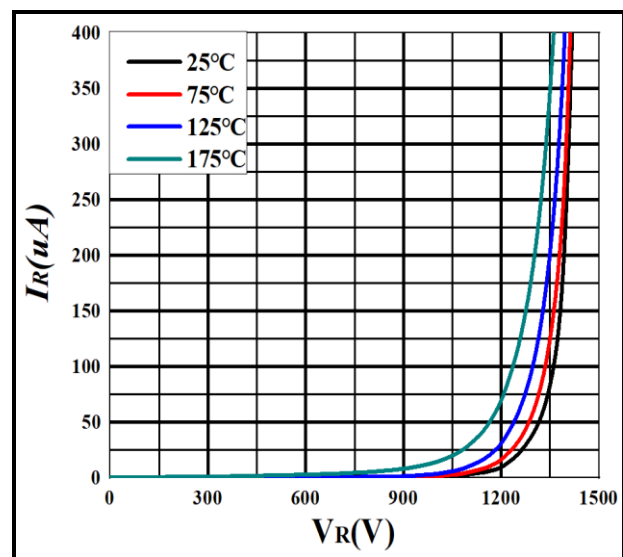

Figure 2. Reverse Characteristics

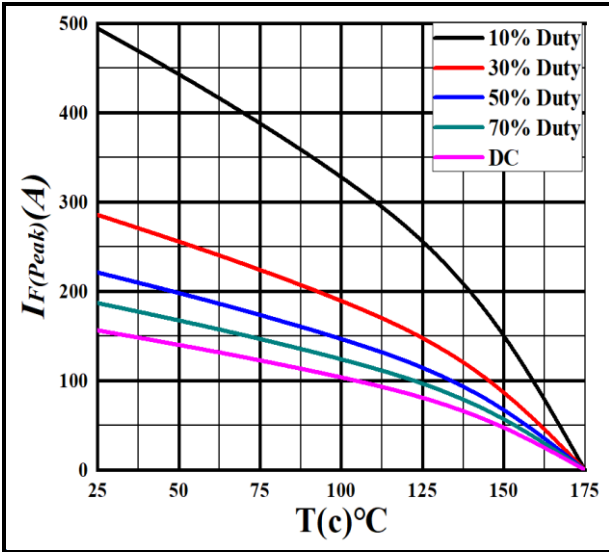

Figure 3. Current Derating

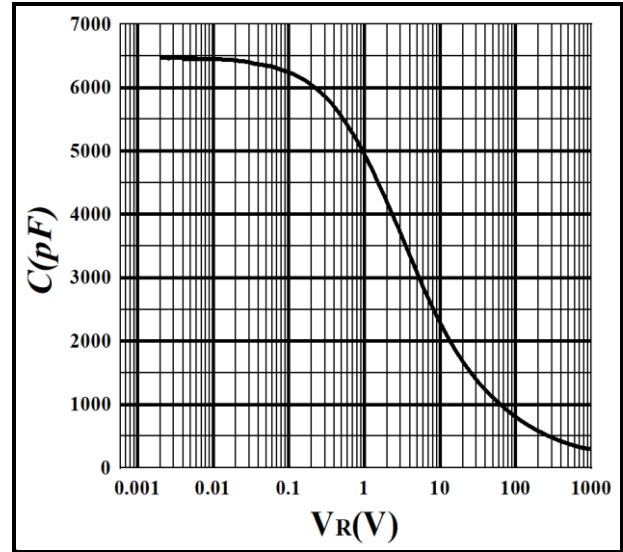

Figure 4. Capacitance vs. Reverse Voltage

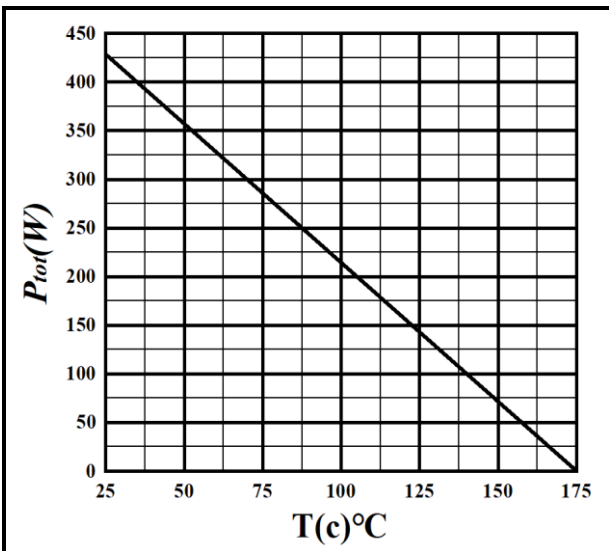

Figure 5. Power Derating

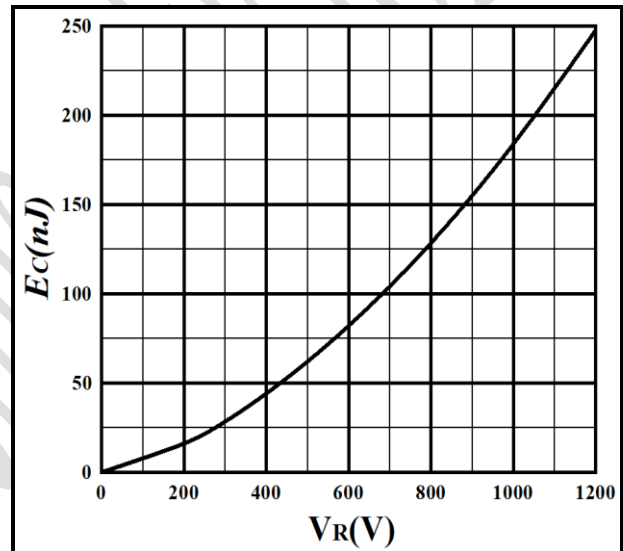

Figure 6. Capacitance Stored Energy

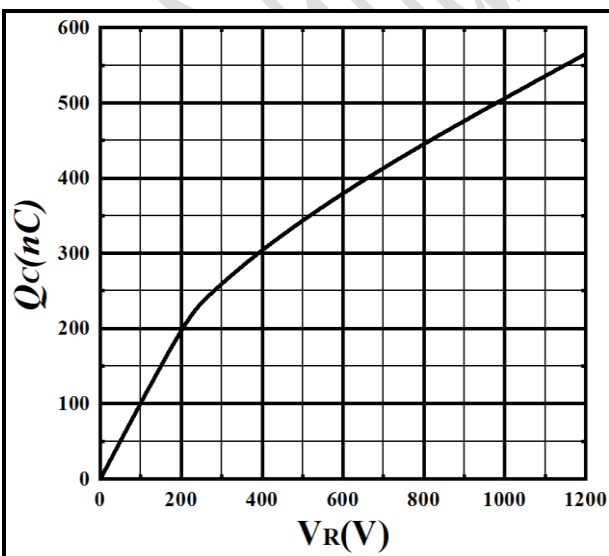
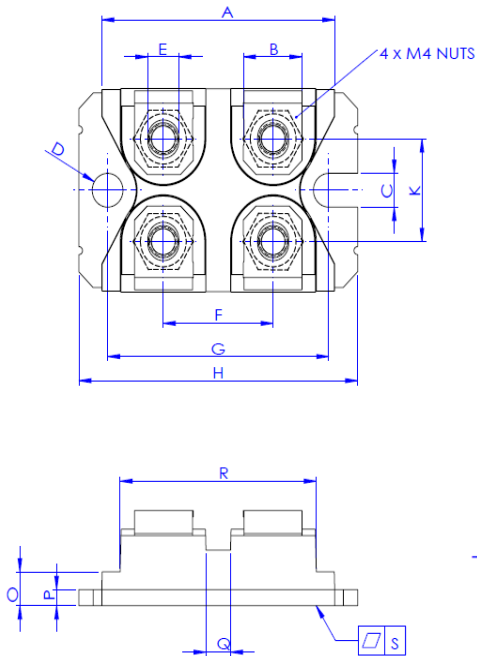

Figure 7. Total Capacitance Charge vs. Reverse Voltage

Package



SYMBOL	mm		
	MIN	NOM	MAX
A	31.50	31.80	32.10
B	7.70	8.00	8.30
C	4.10	4.20	4.30
D	4.10	4.20	4.30
E	4.10	4.24	4.30
F	14.90	15.00	15.15
G	29.80	30.20	30.50
H	37.80	38.00	38.30
I	11.70	11.82	12.20
J	0.75	0.80	0.85
K	12.50	12.75	13.00
M	25.00	25.75	25.50
N	6.70	6.90	7.05
O	4.10	4.20	4.50
P	1.90	2.00	2.10
Q	3.20	3.36	3.60
R	26.60	26.78	27.00
S	-0.03	0.05	0.10

Ordering information

Part Number	SLS120J080A-ISBTH
Package	SOT-227
Unit Quantity	240EA
Packing Type	Tube
RoHS	Yes