

4th Generation 650V/10A SiC Schottky Barrier Diode

Features

- Revolutionary semiconductor material - Silicon Carbide (SiC)
- No reverse recovery
- High-speed switching performance
- Temperature-independent switching behavior
- System cost / size savings due to reduced cooling requirements
- Junction temperature range from -55°C to 175°C
- RoHS compliant

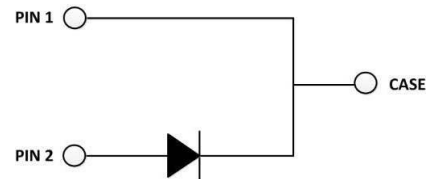

Package Type: TO-220-2L

Potential Applications

- Industrial power supplies: Industrial UPS
- Battery chargers
- Solar inverters
- Switch mode power supplies



Description

The SDS065J010C4 SiC Schottky Barrier Diode (SBD) has been developed using Sanan’s advanced 4th generation SiC SBD technology with the highest performance and reliability. It registers higher efficiency, higher operation temperature and lower loss and can be operated at higher frequency than Si-based solutions. As to the Schottky structure, it shows no recovery at turn-off and allows a low leakage current with reverse voltage up to 650V. It can contribute to system miniaturization and achieve lightweight system design. Using RoHS compliant components, it is qualified for use in industrial application.

Product Specifications

| Device | V _{RRM} | I _F (135°C) | V _F (25°C) | Q _C | Marking |
|--------------|------------------|------------------------|-----------------------|----------------|------------|
| SDS065J010C4 | 650V | 15A | 1.27V | 28nC | DS065010C4 |

CONTENTS

| | |
|--|---|
| Features..... | 1 |
| Potential Applications..... | 1 |
| Description..... | 1 |
| Product Specifications | 1 |
| Table 1 Maximum Ratings..... | 3 |
| Table 2 Thermal Resistance..... | 3 |
| Table 3 Static Electrical Characteristics..... | 4 |
| Table 4 Dynamic Electrical Characteristics | 4 |
| Electrical Characteristic Diagrams..... | 5 |
| Package Information | 7 |
| Recommended Solder Pad Layout..... | 8 |
| Ordering Information | 8 |
| Important Notices – Read Carefully | 9 |
| Warning | 9 |

Table 1. Maximum Ratings

(T_c = 25°C, unless otherwise specified)

| Parameter | Symbol | Value | Unit | Test conditions |
|--------------------------------------|--------------------|---------|------------------|--|
| Repetitive peak reverse voltage | V _{RRM} | 650 | V | T _C = 25°C |
| Surge peak reverse voltage | V _{RSM} | 650 | | T _C = 25°C |
| DC reverse voltage | V _{DC} | 650 | | T _C = 25°C |
| Continuous forward current | I _F | 30 | A | T _C = 25°C |
| | | 15 | | T _C = 135°C |
| | | 10 | | T _C = 155°C |
| Surge non-repetitive forward current | I _{FSM} | 68 | A | T _C = 25°C, t _p = 10ms, half sine pulse |
| | | 55 | | T _C = 150°C, t _p = 10ms, half sine pulse |
| Non-repetitive peak forward current | I _{F,Max} | 563 | A | T _C = 25°C, t _p = 10μs, pulse |
| Surge repetitive forward current | I _{FRM} | 48 | A | T _C = 25°C, t _p = 10ms, half sine wave D = 0.1 |
| Power dissipation | P _{tot} | 115 | W | T _C = 25°C |
| i ² t value | ∫i ² dt | 23 | A ² s | T _C = 25°C, t _p = 10ms |
| Operating junction temperature | T _j | -55~175 | °C | |
| Storage temperature | T _{stg} | -55~175 | °C | |
| Mounting torque | M | 1 | Nm | M3 screw |

Table 2. Thermal Resistance

| Parameter | Symbol | Values | | | Unit | Test condition |
|--|----------------------|--------|------|------|------|----------------|
| | | Min. | Typ. | Max. | | |
| Thermal resistance from junction to case | R _{th(j-c)} | / | 1.30 | / | °C/W | |

Table 3. Static Electrical Characteristics

(T_j = 25°C, unless otherwise specified)

| Parameter | Symbol | Values | | | Unit | Test conditions |
|---------------------|-----------------|--------|------|------|------|---|
| | | Min. | Typ. | Max. | | |
| DC blocking voltage | V _{DC} | 650 | / | / | V | I _R = 100 μA |
| Forward voltage | V _F | / | 1.27 | 1.45 | V | I _F = 10A, T _j = 25°C |
| | | / | 1.45 | 1.70 | | I _F = 10A, T _j = 175°C |
| Reverse current | I _R | / | 5 | 80 | μA | V _R = 650V, T _j = 25°C |
| | | / | 30 | 320 | | V _R = 650V, T _j = 175°C |

Table 4. Dynamic Electrical Characteristics

(T_j = 25°C, unless otherwise specified)

| Parameter | Symbol | Values | | | Unit | Test conditions |
|---------------------------|----------------|--------|------|------|------|---------------------------------|
| | | Min. | Typ. | Max. | | |
| Total capacitance | C | / | 629 | / | pF | V _R = 0V, f = 1MHz |
| | | / | 41 | / | | V _R = 200V, f = 1MHz |
| | | / | 32 | / | | V _R = 400V, f = 1MHz |
| Total capacitive charge | Q _C | / | 28 | / | nC | V _R = 400V |
| Capacitance stored energy | E _C | / | 4.10 | / | μJ | V _R = 400V |

Electrical Characteristic Diagrams

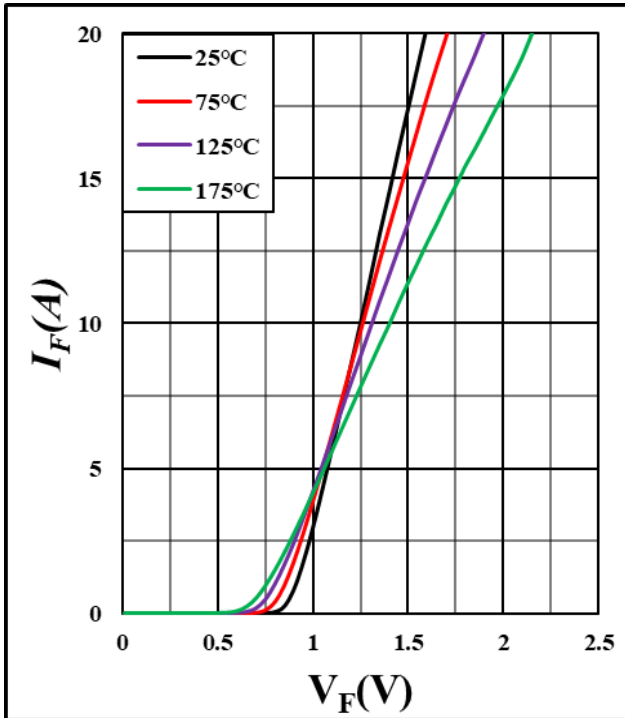

Figure 1. Forward characteristics

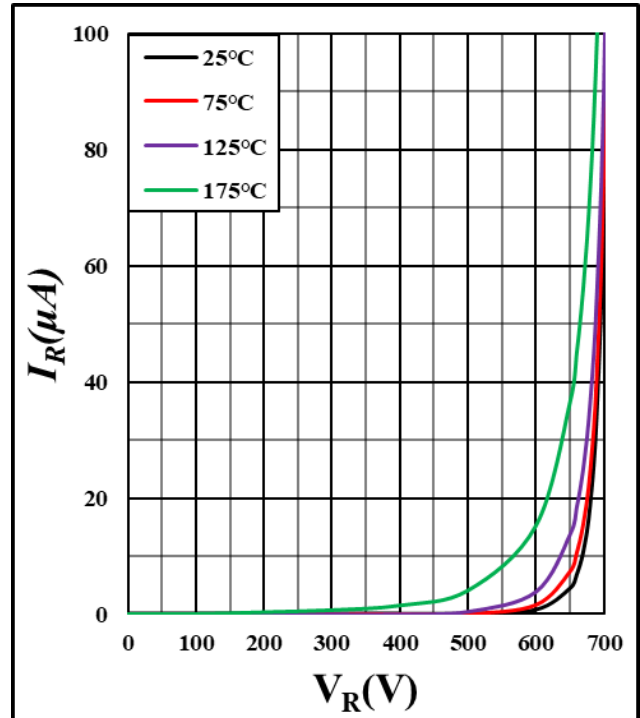

Figure 2. Reverse characteristics

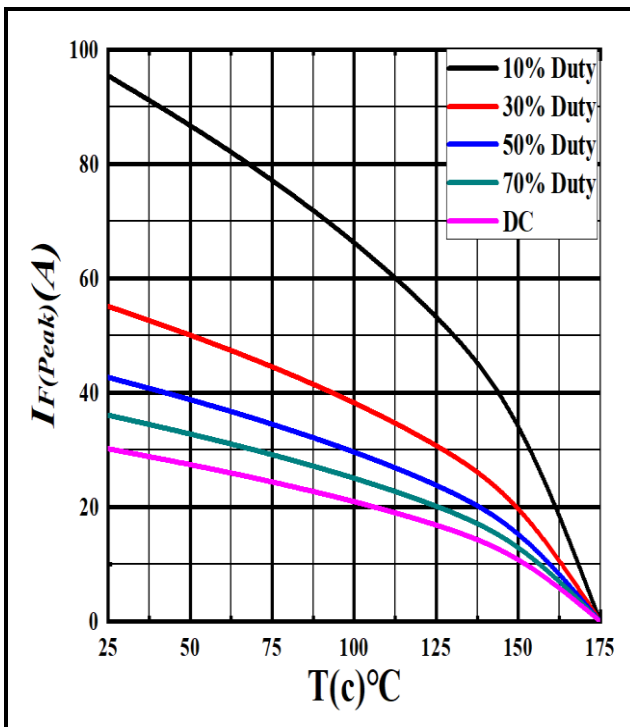

Figure 3. Current derating

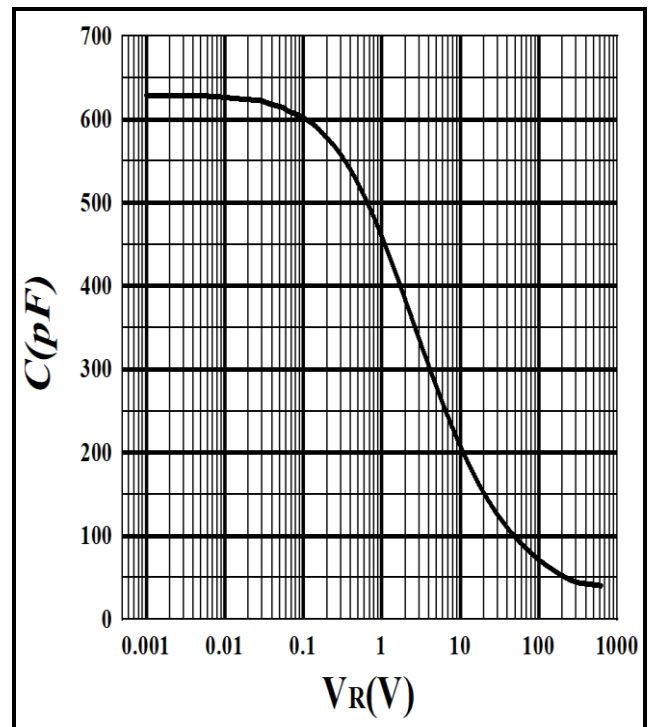

Figure 4. Capacitance vs. reverse voltage

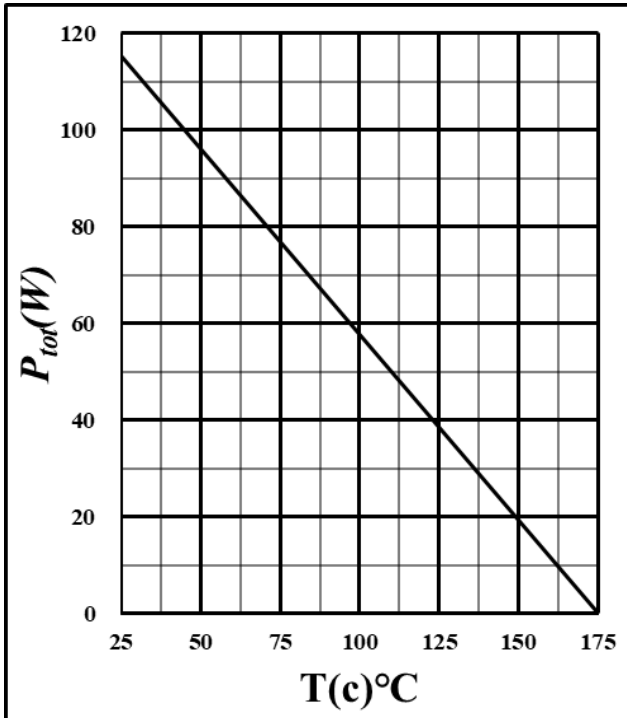

Figure 5. Power derating

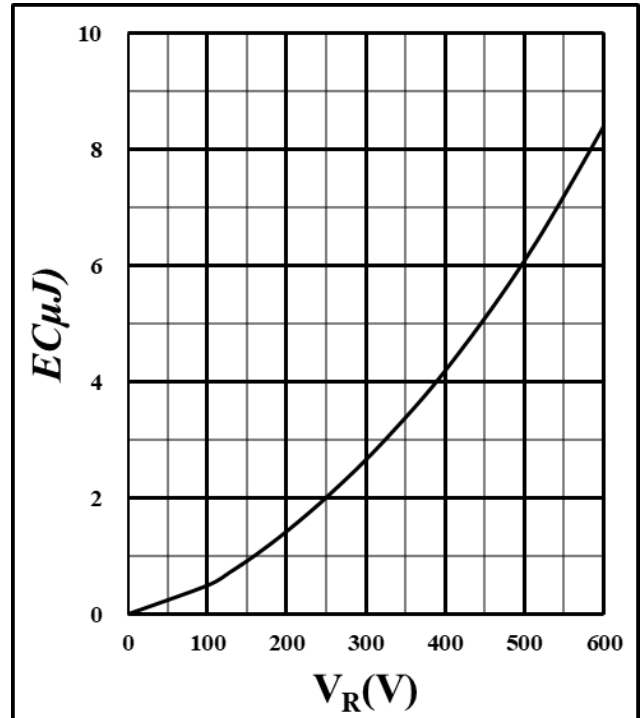

Figure 6. Capacitance stored energy

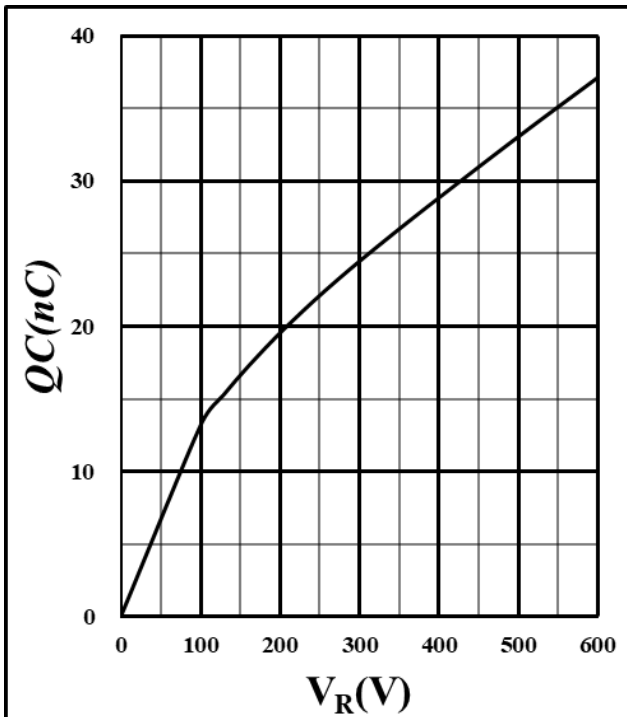

Figure 7. Total capacitance charge vs. reverse voltage

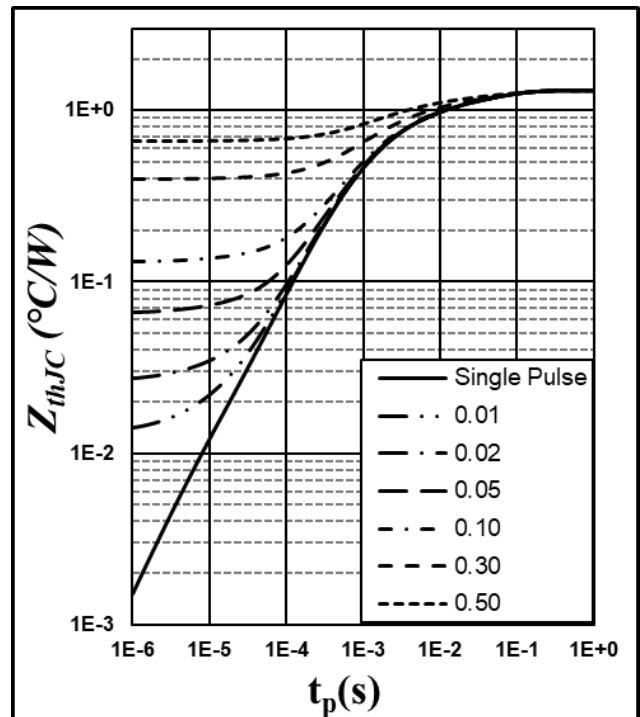
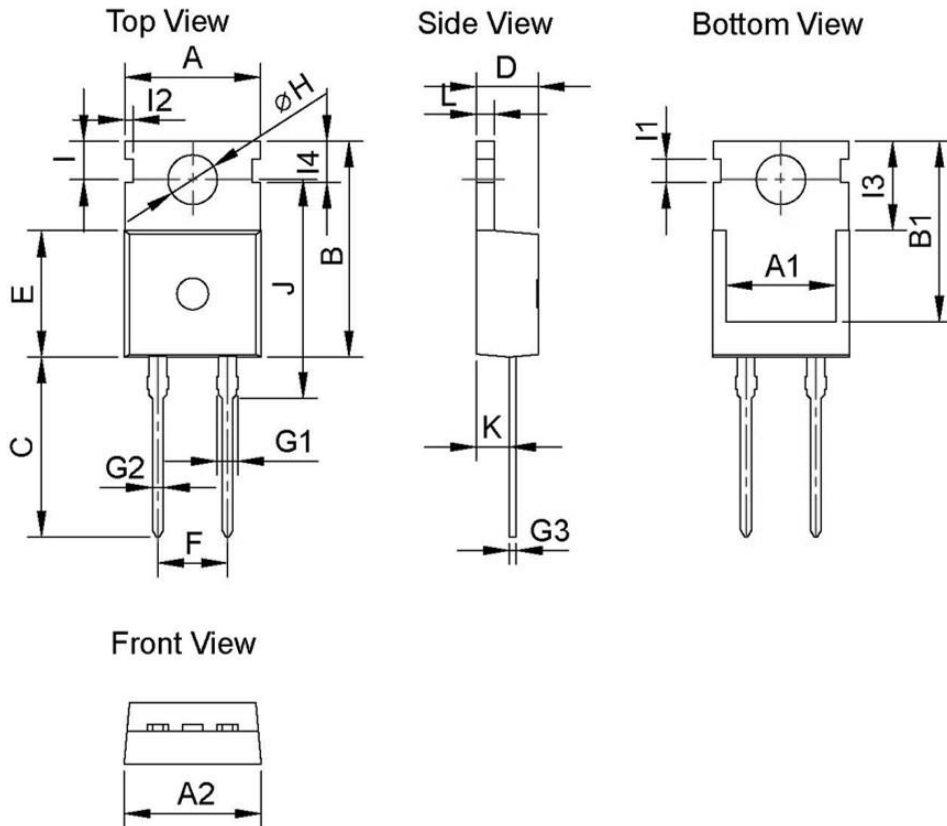

Figure 8. Transient Thermal Impedance
(Junction - Case)

Package Information



| Dimension unit: [mm] | | | |
|----------------------|-----------|-------|-------|
| Symbol | Min | Nom | Max |
| A | 9.66 | 9.90 | 10.28 |
| A1 | 6.90 | - | - |
| A2 | 9.80 | 10.00 | 10.20 |
| B | 15.60 | 15.70 | 15.80 |
| B1 | 13.16 REF | | |
| C | 12.70 | 13.08 | 14.27 |
| D | 4.30 | 4.50 | 4.70 |
| E | 8.59 | 9.20 | 9.40 |
| F | 5.08 BSC | | |
| G1 | 1.32 | 1.52 | 1.62 |
| G2 | 0.70 | 0.80 | 0.95 |
| G3 | 0.45 | 0.50 | 0.60 |
| øH | 3.53 | 3.60 | 3.70 |
| I | 2.70 | 2.80 | 2.90 |
| I1 | 1.70 REF | | |
| I2 | 0.59 REF | | |
| I3 | 6.50 REF | | |
| I4 | 3.00 REF | | |
| J | 15.70 | 15.90 | 16.25 |
| K | 2.20 | 2.40 | 2.60 |
| L | 1.15 | 1.30 | 1.40 |

Recommended Solder Pad Layout

Note: All dimensions are in mm

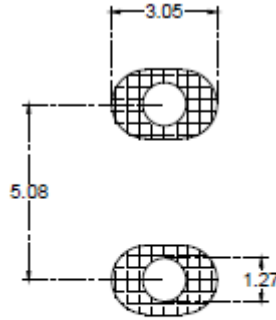

TO-220-2L

Ordering Information

| | |
|---------------|--------------------|
| Part number | SDS065J010C4-CSATH |
| Package | TO-220-2L |
| Unit quantity | 1000 EA |
| Packing type | Tube |

Important Notices – Read Carefully

Before you use our products, you are requested to carefully read this document and fully understand its contents. Sanan Semiconductor Co., Ltd. shall not be in any way responsible or liable for failure, malfunction or accident arising from the use of Sanan's products.

Sanan Semiconductor Datasheets are subject to change. Information presented in this document is from the characterization of engineering lots. Sanan Semiconductor Co., Ltd reserves the right to change limits, test conditions, and dimensions without notice. Information contained in this document are typical values and shall in no event be regarded as a guarantee of characteristics. With respect to any information regarding the application of the product, Sanan hereby disclaims all warranties and liabilities of any kind. The information in this document is exclusively for trained technical staff. It is the responsibility of the customer's technical department to decide the suitability of the product in the customer's application and Sanan Semiconductor Co., Ltd assumes no responsibility or liability whatsoever for the use of the information contained in this document.

In case there is any clause in this document or in any other documents which is contradictory to this clause, this clause shall prevail. This clause shall survive after termination of this document.

Warning

Due to technical requirements, Sanan's products may contain dangerous substances. For detailed information about the substance(s), please contact the Sanan office. Sanan Semiconductor Co., Ltd bears no responsibility for any damage whatsoever due to the substance(s) used in Sanan's products.

Contact info

Website: <https://www.sanan-semiconductor.com/>
<https://www.sanan-semiconductor.com/en>